

Monitor Worthy Design Ltd

incorporating NSC (EASTERN)



Window Films

Glazing Films & Tapes

Miscellaneous Tools

Glazing Accessories

Trade Catalogue

Glass Cutting Equipment

Glass Fixings

Glass Handling Tools

Glass Storage

Friendly Service from a Family Firm

Please note we have a new telephone and fax number:
Tel 01455 202880 Fax 01455 209509

Dear Customer

Monitor Worthy Design Ltd have incorporated the supply and distribution activities of NSC (EASTERN)

We also stock a wide range of TAPES, TOOLS and GLAZING ACCESSORIES, most of which are available for next day delivery.

This catalogue is not an exhaustive list of all our products, so if you cannot see what you require, please telephone – WE WILL DO OUR UTMOST TO HELP.

How to Order...

TELEPHONE	01455 202 880
FAX	01455 209 509
E-MAIL	sales@monprods.co.uk
POST	Unit 1/3 Eaglesfield Industrial Estate Leire, Leicester LE17 5HF

Web site www.worthydesign.co.uk

Monitor Worthy Design Ltd

incorporating NSC (EASTERN)



Contents

Window Films

Solar Reflective Films	1
Safety and Security Films	2
Compliance Stickers	2
Privacy Films	3-4
Patterned Films	3
Coloured Vinyl Films	4
Tinted Films	4
UV Control Film	5
One-Way Mirror Film	5
Conservatory Roof Film	5
Anti-Graffiti Film	5
Shop Window Display Film	6
Manifestation Graphics	6
Personalised Graphics	6
Film Cutting and Application Tools	7-8

Glazing Films and Tapes

Sun Control Inserts	9
Emergency Repair Films	9
Window Protector Film	9
White Temporary Screening Film	10
Carpet Protector Film	10
Handywrap	10
Sandblasting Resist Tape	11
Security Glazing Tape	11
Cloth Tape	11

Mirror Backing Films

Safety Backing to BS6206 Class B	12
Safety Backing to BS6206 Class A	12
Mirror Foil Backing	12

Glazing Accessories

Mirror Adhesive	13
Glass Cleaner	13
PVCU Cleaner	13
Industrial Wipers/Dispenser	13
Transit Pads	14
Corner Protectors	14
Glazing Packers	14
Snap Off Wedges	14
Bench Covering	15
Ventilators	15
Measuring Equipment	16-18

Access Equipment

Conservatory Roof Ladder System	19
Aluminium Staging	19

Glass Cutting Equipment

Oval Cutting Machines	20
Circle Cutters	20
Radius Cutter	20
Glass Cutters	21
Glass Tapper	22
Cutting Oil/Cutter Oiler	22
Strip Cutter	22
Speed Cutter	22
Pliers/Glass Breakers	22-23
Cutting Frames	23
T-squares	23
L-squares	23
Straight Edges	23

Glass Handling Tools

Suction Lifters	24-25
Mounting Suction Tools	25
Power Pump Suction Lifter	25
Side Lifters	26
Carrying Accessories	26
P. P. E.	27

Miscellaneous Tools

Putty Knives	27
Hacking Knives	27
Glaziers Knives	27
Glaziers Hammer	28
Glazing Shovel/Spatula	28
Diamond Hand Pads	28
Diamond Hand Files	28
Glass Smoother	28
Gasket Roller	28
Glaziers Mallets	29
Silicone Jointing Tool	29
Diamond Marking Pen	29
Leather Tool Pouch	29

Glass Storage

A-Frame Trolleys	30
A and L-Frame Storage Racks	30
Glass Cutting Tables	30
Tipping Skips	30

Glass Fixings

Hinges	31
Pig Nose Bolts	31
Channels	32
Glass Clamps	33-35



WINDOW FILMS

We have a very comprehensive range of Premium Quality Window Films for application to glass and plastic materials with over 100 different films available from stock.

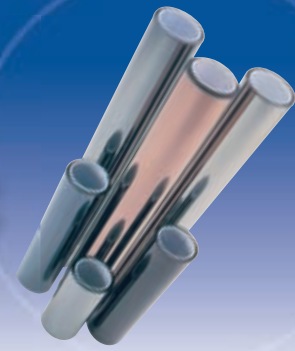

Solar Reflective Films

Reflective films are used for the control of solar heat gain and glare from the sun. The most commonly used film is Silver, but we also stock reflective Bronze, Grey, Blue, Green, Gold and Copper. Internal and external grades are available. The films also provide daytime privacy, save on air conditioning costs and reduce winter heat loss through the glass.

Solar Reflective Films

Film Code	Roll Size
Silver 80 High Reflective Film	915mm x 30m
	1220mm x 30m
	1525mm x 30m
	1820mm x 30m
	1220mm x 15m
Silver 80 Exterior Reflective Film	1220mm x 30m
	1525mm x 30m
Silver 70 Medium Reflective Film	1220mm x 30m
	1525mm x 30m
Silver 50 Light Reflective Film	1525mm x 30m
Bronze 80 High Reflective Film	1220mm x 30m
	1525mm x 30m
Grey 80 High Reflective Film	1525mm x 30m
Blue 80 High Reflective Film	1525mm x 30m
Green 80 High Reflective Film	1525mm x 30m
Gold 80 High Reflective Film	1525mm x 30m
Copper 80 High Reflective Film	1525mm x 30m
Neutral 65 Medium Grey Film	1525mm x 30m
Low Mirror 65 Medium Bronze Film	1525mm x 30m
Solar 55 Heat Saving Film	1525mm x 30m
Solar 80 Heat Saving Film	1525mm x 30m



Silver reflective film applied to Suffolk Fire Service HQ



Bronze reflective film applied to BT Laboratory Buildings



Blue reflective film applied to office block in London

Specification sheets are available on all the film types.



Films can be purchased in commercial rolls or cut lengths off the roll.

Tel 01455 202880 Fax 01455 209509



WINDOW FILMS

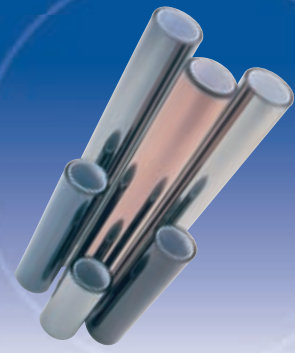

Safety And Security Films

Safety films make glass safer by strengthening it against breakage and by holding the glass together in the event of impact. They are used to upgrade existing glass to a safer specification, meeting at least BS6206 Class B (EN12600 Class 2B2). The thicker films (7mil or 8mil) meet the requirements of BS6206 Class A (EN12600 Class 1B1). These films are essential for the protection of personnel and property.

Safety/Security Films

Film Code	Roll Size
4 mil Clear Safety Film (100 microns)	915mm x 30m
	1220mm x 30m
	1525mm x 30m
	1820mm x 30m
	2000mm x 30m
	1220mm x 15m
4 mil Clear Safety Film (100 microns) Exterior	1220mm x 30m
	1525mm x 30m
7 mil Clear Safety Film (175 microns)	1220mm x 30m
	1525mm x 30m

Combined Films are available with solar reflective or privacy screening properties, as follows:

Film Code	Roll Size
4 mil Silver Solar/Safety Film (100 microns)	1220mm x 30m
	1525mm x 30m
8 mil Silver Solar/Safety Film (200 microns)	1525mm x 30m
4 mil White Matt Obscuring/Safety Film (100 microns)	1525mm x 30m

Compliance Stickers

Rolls of Compliance Stickers 30mm dia.
 Inscribed "100 micron film tested to BS6206".
 Used with clear safety film. Rolls of 1000
 (Can be personalised)



Safety film applied to large showroom windows



Safety film in action



Combined solar/safety film applied to Grade II listed building

2

Specification sheets are available on all the film types.

Combined Solar and Safety Films also available in Bronze and Grey tints.

Tel 01455 202880 Fax 01455 209509



WINDOW FILMS

Privacy Films

A wide variety of films are available, including translucent, opaque, total 'black-out', patterns or solid colours

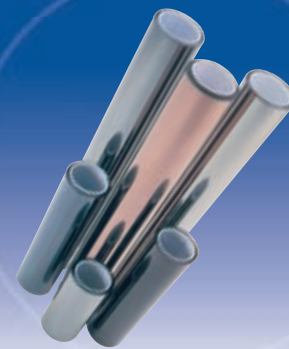

Privacy Films

Film Code	Roll Size
White Matt Sandblast Effect Film	915mm x 30m
	1220mm x 30m
	1525mm x 30m
	1830mm x 30m
	1220mm x 15m
	1525mm x 15m
Bronze Matt Obscuring Film	1525mm x 30m
Grey Matt Obscuring Film	1525mm x 30m
Silver Matt Solar Control/Obscuring Film	1525mm x 30m
Matt Frost Obscuring Film (nearest film to stippolyte glass)	1350mm x 50m 1350mm wide
Total Black Out Film	1525mm x 30m
Total White Out Film	1525mm x 30m
Acid X Vinyl Film	1220mm x 50m 1220mm wide
Dusted Effect Vinyl Film	1220mm wide
Frosted Crystal Vinyl Film	1220mm wide
Honeycomb Privacy Film	450mm x 15m
	900mm x 10m



Frosted Crystal in bands to partition glazing



White Matt Privacy Film

Patterned Films

Film Code	Roll Size
Classic (Etch Pattern Film)	915mm wide
Claustra (45mm squares with clear gaps)	1170mm wide
Sirius (18mm stripes with clear gaps)	1170mm wide
Stratos (35mm stripes with clear gaps)	1170mm wide

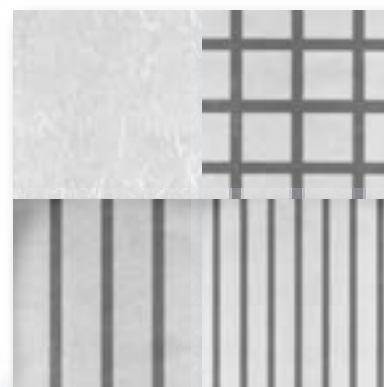

Clockwise from top left: Classic, Claustra, Sirius, Stratos

Films can be purchased in commercial rolls or cut lengths off the roll.

Tel 01455 202880 Fax 01455 209509



WINDOW FILMS

Privacy Films cont'd

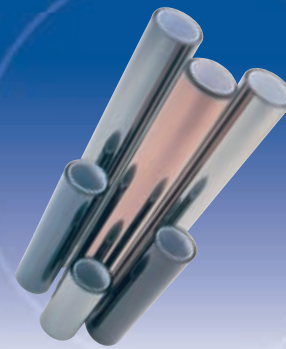

Coloured Vinyl Films

Film Code	Roll Size
Matt Black	1220mm wide
Gloss White	1220mm wide
Colours	1220mm wide

(Full range of colours available, some colours available in 1525mm wide – please enquire)

Vinyl Films can be fitted internally or externally.



Vast colour range of vinyl films

Tinted Films

Tinted films are non-reflective and available in a choice of colours – grey and bronze – as well as blue, green, red and amber. These films are mainly used for solar glare control where a mirror finish is not wanted or for aesthetic purposes.

Tinted Films

Film Code	Roll Size
Grey Tinted Films	
Charcoal 95 (Limo Black)	1525mm x 30m
Charcoal 80 (Dark Grey)	1525mm x 30m
Charcoal 65 (Medium Grey)	1525mm x 30m
Charcoal 50 (Light Grey)	1525mm x 30m
Charcoal 95 Exterior (Limo Black)	1525mm x 30m
Bronze Tinted Films	
Bronze 75 (Dark Bronze)	1525mm x 30m
Light bronze tint also available – please enquire	
Coloured Tint Films	
Blue Tint	1525mm wide
Green Tint	1525mm wide
Red Tint	1525mm wide
Amber Tint	1525mm wide



Grey tinted film applied to vehicle windows



Grey tinted film applied to boat cabin windows

Most films are available from stock, please phone for samples.

Tel 01455 202880 Fax 01455 209509



WINDOW FILMS

Special Films

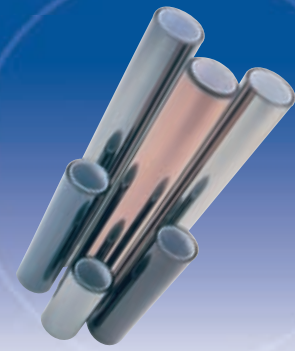

UV Control Film

This film is designed for museum conservation and retail use to protect exhibits, displays and furnishings from UV Radiation, which is one of the main causes of fading.

Film Code	Roll Size
Clear I UV	1525mm x 30m



UV control film in Bodleian Library, Oxford University

Special One-Way Mirror Film

Vista 90 film has a highly reflective (mirror) finish on one side with a dark grey tint on the other.

Film Code	Roll Size
Vista 90 One-Way Mirror film	1525mm x 30m
Vista 90 One-Way Exterior Mirror Film	1525mm x 30m



Vista 90 reflective mirror film on Police station

Conservatory Roof Film

A solar control film specially designed for internal application to polycarbonate roof panels.

Film Code	Roll Size
Suncool (conservatory roof film)	762mm x 30m
	1525mm x 30m



Conservatory with solar control film applied

Anti-Graffiti Film

A clear film for protection of glass surfaces. Extra smooth, scratch resistant coating with a special adhesive for easy removal.

Film Code	Roll Size
Anti-Graffiti Film (clear)	1220mm x 30m
	1525mm x 30m



Anti-graffiti film being removed

Films can be purchased in commercial rolls or cut lengths off the roll.

Tel 01455 202880 Fax 01455 209509



WINDOW FILMS

Special Films cont'd

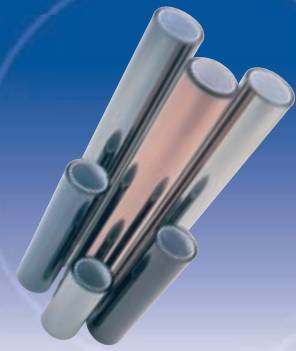

Shop Window Display Film

A virtually clear window film which rejects 50% of the sun's heat. High light transmission gives good 2-way visibility and UV Light Transmission is less than 4%.

Film Code	Roll Size
Spectra 30 Solar Control Film	1525mm x 30m
Spectra 33 Solar Control Film	1525mm x 30m



Jean Fox store with shop window display film

Manifestation Graphics

Pre-cut strips of Acid Etch circles or squares for glass marking. Required to satisfy Building Regulations Document M.

Film Code	Size
Acid Etch Circles 50mm diameter with 50mm spaces	750mm strips or 5m rolls
Acid Etch Squares 50mm x 50mm with 50mm spaces	750mm strips or 5m rolls



Manifestation graphics applied to large windows

6

Personalised Graphics

Any personalised graphics or logos can be produced and cut to your requirements. Please phone for advice.



Specially made logo applied to a reception desk

If you have a film requirement not listed on these pages, please phone us as we can source any film type or offer a near equivalent

Tel 01455 202880 Fax 01455 209509



FILM CUTTING AND APPLICATION TOOLS

We stock all of the tools required for film application.



Film Handler Cutting Machine 1525mm
c/w 2 cutting heads (Steps not included)



Professional Pressure Sprayer
with hose & lance. 5 litre



Hand-Held Pressure Sprayer – 1 litre



Smoothie Squeegee (9")



Wooden Handle Squeegee (8")



Deluxe Squeegee (6")

7



Triumph Scraper 6"
Replacement blades (pk 25)



Unger Heavy Duty Scraper
Replacement blades (pk 10)



Stainless Trimming Knife
Stainless snap-off blades (pk 50)



5-Way Edge Trimming Tool



Window Cleaning Squeegee



3M Gold Card
and Teflon Squeegee

WITH OVER 35 YEARS EXPERIENCE IN THIS FIELD, WE CAN PROVIDE ADVICE
AND GUIDANCE IN ALL FILM APPLICATION JOBS – PLEASE GIVE US A CALL.

Tel 01455 202880 Fax 01455 209509



FILM APPLICATION KIT

Our top quality, superior tool kit is designed with window film professionals in mind. With all the necessary tools for film application. (Sprayer not included)



Film Application Kit Includes:

- 9" black smoothie squeegee
- 6" deluxe squeegee
- 6" Triumph scraper
- 6" Triumph scraper blades (pk. 25)
- Stainless steel trimming knife
- Stainless snap-off blades (pk. 50)
- 5-way edge trimming tool
- 12" window cleaning squeegee
- Stainless steel knife blades (pk. 5)
- Roll of masking tape
- Lint free cloths (pk. 10)
- 4" white teflon squeegee

All in a quality 20" rigid toolbox!*



8

* Design of toolbox may vary slightly

Tel 01455 202880 Fax 01455 209509



GLAZING FILMS AND TAPES



Sun Control Inserts

Embossed sun control film in strips for insertion within fluted polycarbonate roof panels. The **NEAT** and **SIMPLE** solution to solar heat gain through conservatory roofs.

Roll Size

Sun Control Insert Silver	22.5mm x 50m
Sun Control Insert Gold	22.5mm x 50m
Fitting Kit (comprises hole punch and plastic insert rod)	

Any roll width available to order. Phone for a quote.

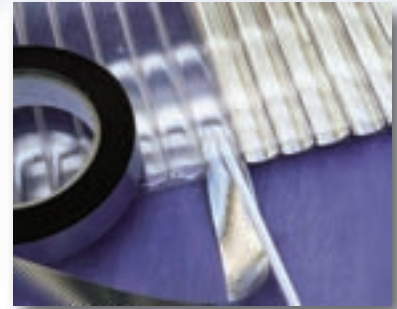

Emergency Repair Films

A simple, effective adhesive covering which acts as a temporary coating for broken or cracked glass surfaces. Quicker and more cost effective than boarding up with no loss of natural light.

Glasfix

Roll Size

Glasfix 175 (175 microns with grid backing sheet)	1020mm x 15m
Glasfix 90 (90 microns with grid backing sheet)	600mm x 50m
Glasfix 90 (90 microns with plain backing sheet)	600mm x 50m
Glasfix 90 (90 microns with plain backing sheet)	500mm x 20m



Window Protector Film

Protects against paint, scratches, mortar splashes and other damage. Self adhesive, low tack film that lasts for up to 6 months. Easily peeled off, leaving no residue.

Roll Size

Window Protector Film	400mm x 100m
(Low tack 50 micron clear film)	500mm x 100m
	700mm x 100m

Any roll width available to order. Phone for a quote.

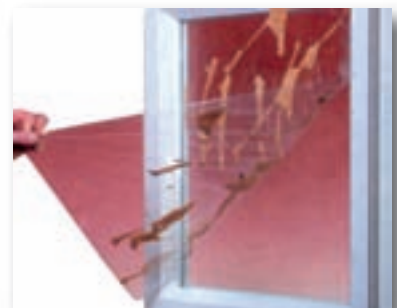

Suppliers nationwide to the Glazing Trade

Tel 01455 202880 Fax 01455 209509



GLAZING FILMS AND TAPES



White Temporary Screening Film

A **BRILLIANT** and **SIMPLE** product that both protects the glass and provides a privacy screen in one low tack temporary film.

Roll Size

Temporary Screening Film (White low tack film)	1000mm x 25m
---	--------------



Carpet Protector Film

Grips firmly to all varieties of carpet. Safer than dustsheets, specially on stairs. Puncture and tear resistant.

Roll Size

Carpet Protector Film	600mm x 100m
(Medium tack 60 micron clear film)	1200mm x 100m



10

Handywrap

A useful stretchwrap film that only adheres to itself, not the items being wrapped.

Roll Size

22 micron Handywrap (Box of 12) Easy to use dispensers available	100mm x 150m
---	--------------



Friendly service from a family firm – Next Day delivery

Tel 01455 202880 Fax 01455 209509



GLAZING FILMS AND TAPES



Sandblasting Resist Tape

127 micron White Vinyl Tape. Used as a sandblast stencil for light blasting of glass.

Die cuts clean with no residue transfer upon removal.

	Roll Size
Sandblast Resist	6" x 20 yards
(127 micron (5mil) tape)	12" x 20 yards
	18" x 20 yards
	24" x 20 yards
	36" x 20 yards
	48" x 20 yards



Security Glazing Tape

Double sided black PVC foam tape. Used extensively for permanently fixing double glazed sealed units within the frame for security purposes.

	Roll Size
Security Glazing Tape	10mm x 3mm x 25m
(Double sided PVC foam tape)	12mm x 3mm x 25m
Trim Tape	10mm x 1mm x 50m
(Double sided PVC foam tape)	12mm x 1mm x 50m

Other sizes available to order. Please phone.



Cloth Tape

Black polyethylene coated cloth adhesive tape with high tack pressure sensitive adhesive. Used as an edging tape for double glazed sealed units.

	Roll Size
Black Cloth Tape	30mm x 50m
(for d.g.s.u)	38mm x 50m
	45mm x 50m



For all your Films, Tapes, Tools and Accessories

Tel 01455 202880 Fax 01455 209509



MIRROR BACKING FILMS



Clear Mirror Safety Backing Film

A clear 60 micron thickness polypropelene safety film with acrylic adhesive. Impact tested to BS 6206 Class B (EN 12600 Class 2B2)

Code	Roll Size
MSB60B	300mm x 100m
	450mm x 100m
	600mm x 100m
	900mm x 100m
	1200mm x 100m
MSB60B - RL (With printed grid release liner)	600mm x 50m
MSB60B - PRL (With plain release liner)	600mm x 50m



White Woven Mirror Safety Backing Film

A woven, 133 micron polyethylene film, impact tested to BS6206 Class A (EN12600 Class 1B1). Suitable for use with mirror adhesive. High tear resistance.

Code	Roll Size
MSB133A (Extra strong film)	305mm x 100m
	305mm x 275m
	610mm x 100m
	610mm x 275m
	762mm x 275m
	915mm x 100m
	915mm x 275m
	1220mm x 100m
1220mm x 275m	



12

Mirror Foil Backing Film

40 micron Aluminium Foil Tape with a pressure sensitive acrylic adhesive and a release liner for easy application. Protects silvering from moisture and salt corrosion and enables adhesives to be used for fixing.

Code	Roll Size
MFB40 (With backing sheet for easy application)	150mm x 46m
	300mm x 46m
	450mm x 46m
	600mm x 46m
	900mm x 46m



Saving £££'s on your glazing supplies

Tel 01455 202880 Fax 01455 209509



GLAZING ACCESSORIES



Mirror Adhesive

A neutral, silicone based adhesive for fixing mirrors that remains permanently elastic after curing.

	Size
Mir-o-bond / Schenk 551 adhesive (Neutral and elastic adhesive)	310 ml tube Box/15 tubes

Mirror Fixings are also available – please enquire



Glass Cleaner

Excellent smear-free cleaning agent for all glass and mirrors.
1 litre spray bottle



13

PVCU Cleaner

Powerful cleaning agents remove ingrained dirt and restore any pvcu surface to its original colour. 1 litre bottle



Industrial Wipers

2-ply industrial quality wipers. Excellent absorbency. Perforated sheets enable easy and controlled dispensing.
280mm x 400m roll (1000 sheets per roll) 2 Roll Pack

Wiper Dispenser

Designed to hold wiper rolls for speed and convenience.



Can't see what you need? Please give us a call

Tel 01455 202880 Fax 01455 209509



GLAZING ACCESSORIES



Transit Pads

High density foam pads with low tack adhesive protect glass in storage and during transit.

	Size
Pad size 19mm x 25mm x 4mm	1000 per roll
	5000 per roll
	20,000 per roll



Corner Protectors

Protect glass corners during transit and storage.
Re-useable time after time.

4mm (Red)	1000 per box
6mm (Blue)	1000 per box
8-10mm (Clear)	100 per box

Other sizes available to order. Phone for a quote



Glazing Packers

Bargain bucket of 300 mixed flat packers (28mm x 100mm),
50 x 6 sizes ranging from 1mm-6mm.

In a handy plastic container – ideal for van or site use.

NATURAL Packers 9mm x 100mm available in 1mm,
2mm and 4mm thick. Ideal for partitions.

Please phone with your enquiry for glazing packers – common sizes are in stock and specials can be ordered.



Snap Off Wedges

This is a **NEW** and **INNOVATIVE** product that is perfect for fixing windows and door frames.

- Position frame and tap in the wedge.
- Just snap off clean

There are no sharp tools needed to cut the wedge and it doesn't fall out due to the unique gripper comb. One size does all jobs – 200mm x 42mm in a 1-8mm slope. In packs of 50.



Suppliers nationwide to the Glazing Trade

Tel 01455 202880 Fax 01455 209509



GLAZING ACCESSORIES



Bench Covering

Give your cutting bench a Facelift!

Bench Felt

Available in 2m wide rolls. Tough product with exceptionally long life. Perfect for cladding cutting tables, racks, frames, cradles etc.

Colour: dark grey / black

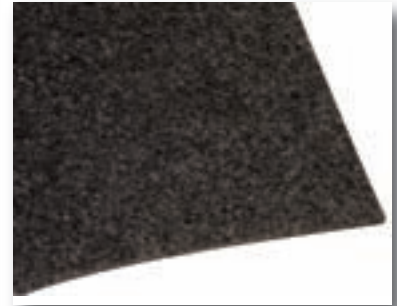

Flotex

Available in 2m wide rolls. High grade carpet quality – waterproof, flame resistant, stain resistant and extremely hardwearing. Straight fibres release the dirt. Colour may vary.

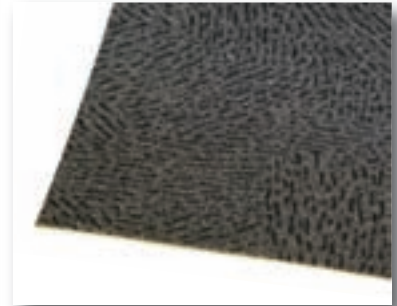

15

Spray Adhesive

Superspray adhesive for fixing bench covering. 500ml containers



Ventilators

Vent-a-matic

Vent-a-matic Rotary Ventilator – 162mm diameter aperture.

Complete with cord control and storm guards.

Models available for either single or double glazing.



Friendly service from a family firm – Next Day delivery

Tel 01455 202880 Fax 01455 209509



MEASURING EQUIPMENT

A range of electronic and mechanical measuring tools for the glass trade

ESSENTIAL EQUIPMENT FOR THE GLAZING PROFESSIONAL



Merlin Lazer Gauge

A remarkably simple but effective precision measuring instrument that enables accurate measurement of glass and air gap thickness in single, double and triple glazed units at the touch of a button. Also identifies laminated and coated glass indicating on which surface the coating is present. No glass removal necessary.



**Easy
Quick &
Accurate**

Merlin TGI

Instant Toughened Glass Indicator for single and multipane units. Compact, lightweight, reliable and affordable. Complements the lazer gauge providing the most convenient glazing health and safety risk assessment kit available.



Merlin Low E Detector

Detects Pilkington K Glass and other Low-Emissivity coatings and indicates on which surface it is present.



Merlin Lazer Glass Analysis Kit

We can now offer all three Merlin measuring tools in one compact kit with a case. This is the perfect solution for anyone who needs to test and measure glass in situ without the need to de-glaze.



16

For all your Films, Tapes, Tools and Accessories

Tel 01455 202880 Fax 01455 209509



MEASURING EQUIPMENT



Glass-o-meter

For measuring the total thickness of installed window units.
Made of plastic.



Flexi-meter

Similar tool to the Glass-o-meter but of sturdy metal construction. Comes boxed with its own protective carrier.



17

Messfix

One man surveying made simple. Sturdy telescopic rule with built in measuring tape and heavy duty rewind. Integral 2-way spirit level facilitates correct horizontal and vertical measuring. Ideal for window frame measuring.

Code	Measuring Range
210300	0.70m to 3.00m
210400	0.86m to 4.00m
210500	1.07m to 5.00m



Messtronic Easy

Electronic telescopic rule with easy to read LCD display. Based on proven Messfix concept. Zero button retains measurement information which can be read at a more convenient time.

Code	Measuring Range
430300	0.70m to 3.00m
430500	1.04m to 5.00m



Saving £££'s on your glazing supplies

Tel 01455 202880 Fax 01455 209509



MEASURING EQUIPMENT



Winklefix

Performs precise angle measurements quickly with utmost ease. Angles shown in degrees in the analogue display – Accurate to $\pm 0.25^\circ$. Two integral spirit levels ensure true horizontal and vertical positioning. Measures 0–180°

Code	Arm Length
600300 Shorty	300mm
600430 Mini	430mm
600600 Classic	600mm



Winkletronic Easy Digital Angle Finder

An electronic measuring device to precisely measure and transfer angles to $\pm 0.2^\circ$. The measured angles are easily read from the large digital display. Arm length 400mm. Two integral spirit levels ensure true horizontal and vertical positioning. Measures 0–200°. It features a hold function to keep a value on display.



18

Economy Digital Angle Finder

A smaller and less precision instrument to the Winkletronic Easy, but at a very economical price. Accurate to $\pm 0.5^\circ$ and arm length 250mm. Two integral spirit levels ensure true horizontal and vertical positioning. Measures 0–220°. Requires 1 x PP3 battery (not included).



Can't see what you need? Please give us a call

Tel 01455 202880 Fax 01455 209509



ACCESS EQUIPMENT



Bavaria Conservatory Ladders

Used by most of the major window firms, this unique ladder system has been specifically designed for the installation, maintenance and cleaning of conservatory roofs. With only one person needed to erect and use it, this system offers a safe solution, whilst saving you time, money and manpower. Certified to EN131.

Description	Max Height
Conservatory Ladder Kit	2.5m
Comprises:	ground to gutter
2 x 6 rung ladders	
Load spreading bar	
Telescopic base unit	
Adjustable foot extensions	
Ground pins	
Adjustable conservatory module (0°–50°)	

For larger conservatories, lean-tos or fragile roofs, the maximum length on the roof can be increased by adding in longer ladder sections, as detailed below.

Description	Length
8 Rung Ladder Section	2.4m
10 Rung Ladder Section	3.0m
12 Rung Ladder Section	3.6m
Extra Long Spreader Bars	1.6m



Accessing the Inaccessible



Bavaria Conservatory Platform

The Conservatory Platform is a versatile, lightweight work platform that mounts securely onto the Conservatory Ladder. Providing a level work area with a sturdy guardrail makes it an ideal solution for safe access to windows above conservatories.



Bavaria Alu Staging

A lightweight, easy to use alternative to conventional scaffolding, this aluminium staging system comes in a variety of lengths ranging from 3.0m to 8.2m. Alu Staging provides a stable work platform for installing windows, fascias and guttering. Staging hooks, single and double sided guardrails with integral aluminium toeboards and safety nets are also available.



Friendly service from a family firm – Next Day delivery

Tel 01455 202880 Fax 01455 209509



GLASS CUTTING EQUIPMENT

All our tools are manufactured to the highest specification



Oval Cutting Machine

Cast aluminium precisely machined parts and calibrated bars. Short bar for small ovals 160–700mm; long bar for ovals up to 1400mm. Changeable cutting head with 135° HM Carbide wheel. Oil reservoir continuously lubricates wheel and axle.



Oval Extension Kit

Enlarges the oval cutting range up to 2300mm. Kit includes one calibrated bar and two extension channels.



Small Oval Cutter

Cast aluminium body, precisely machined brass parts and engraved calibrated bars. Cutting range 100–400mm. Changeable cutting head with 135° HM Carbide steel.



20

Suction Circle Cutters

Precisely calibrated rod; long life non abrasive lever; self turning ball handle. Cross arrows on the cup enable exact positioning of the circle on a marked centre. Minimum diameter 85mm. Cutting ranges available 600mm, 1200mm and 2000mm.



Radius Cutters

Rigid construction. Calibrated bar for exact cutting of round corners. Cutting range 20–120mm and 20–200mm.



For all your Films, Tapes, Tools and Accessories

Tel 01455 202880 Fax 01455 209509



GLASS CUTTING EQUIPMENT



Hasal Glass Cutters

Oil Glass Cutter (a) and (b)

HM Tungsten carbide wheel | 35°. Interchangeable cutting head, all metal body with oil tube. Narrow and wide cutting heads available.

Hasal Point Steel Head Cutter (c)

HM Tungsten Carbide wheel | 35°. For straight or curved cutting. Wooden handle.

Hasal Interchangeable Cutter (d)

Interchangeable HM Tungsten Carbide wheel | 35°; steel turret and axle.

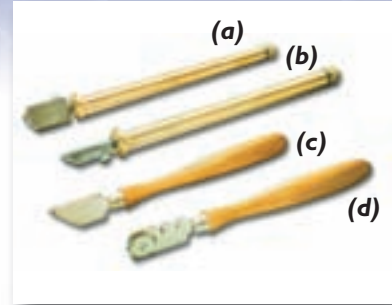

Shaws Glass Cutters

Shaws TW701 Shawcut (e)

Tungsten Carbide glass cutter.

Shaws TW706 Goldcut (f)

Tungsten Carbide glass cutter with cast iron body.

Shaws TW702 Maxicut (g)

Tungsten Carbide glass cutter with wooden handle and swivel head.

Shaws SW100 Cutter (h)

Single steel wheel glass cutter (red handle).

Shaws SW102 Cutter (i)

Interchangeable steel glass cutter (orange handle).

Shaws SW104 Cutter (j)

Six wheel steel glass cutter (blue handle).

Shaws SW105 Cutter (k)

Six wheel steel glass cutter (wooden handle).

Shaws TW920 Oil Glass Cutter (l)

Oil-filled glass cutter.

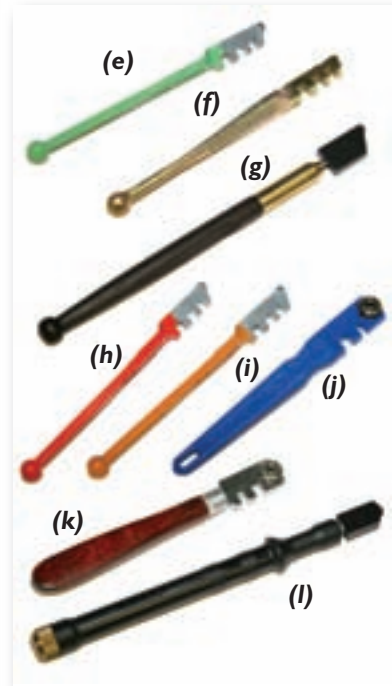

Toyo Glass Cutters

Toyo TC20 Cutter (m)

Quality glass cutter with a tungsten carbide cutting wheel and wooden handle.

Toyo TC17 Oil Glass Cutter (n)

Quality self-oiling cutter with a tungsten carbide cutting wheel and brass handle.



Premium quality tools at very competitive prices

Tel 01455 202880 Fax 01455 209509



GLASS CUTTING EQUIPMENT



Glass Tapper (o)

Wooden handle with brass ball for running cuts.

Cutting Oil (not illustrated)

Lubricating oil for all cutters comes in 50ml and 1 litre containers.

Cutter Oiler (p)

Oiled felt at the base of the reservoir lubricates the wheel and axle of the cutter. Suction pad base.

Strip Cutter (q)

Slides along the edge of the glass to obtain accurate parallel glass strips. Features a calibrated bar and changeable cutting head. Several cutting heads can be used at one time. Bar lengths available: 200mm, 400mm, 800mm.

Speed Cutter (r)

Cast aluminium precision tool with specially designed ball bearing rollers which follow the glass edge. Calibrated bar; HM Carbide 135° wheel and oil reservoir. Lengths available: 800mm, 1300mm, 1900mm.

Standard Pliers

Black handled pliers, 200mm long with 26mm jaw width.

HM Tungsten Carbide Jaw Pliers

Red handled pliers, 200mm long with 26mm jaw width.

Cut-Running Pliers

3 point glass breaker. For glass 1–8mm thick with screw for precision adjustment 200mm long with 26mm jaw width.

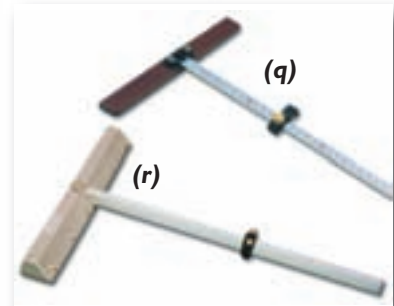

Can't see what you need? Please give us a call

Tel 01455 202880 Fax 01455 209509



GLASS CUTTING EQUIPMENT



Thick Glass Breaking Pliers

For glass 10–19mm thick. 400mm long with 36mm jaw.



Thick Glass Breaker

Cut running pliers for thick glass up to 20mm. Steel construction with teflon points where glass touches. Fine adjustment for glass thickness.



23

Cutting Frames

Strong, rigid design with calibrated bars for multiple cutting of the same size. 600mm and 1000mm lengths available.



T-Squares (s)

Available in 800mm, 1050mm and 1250mm lengths.

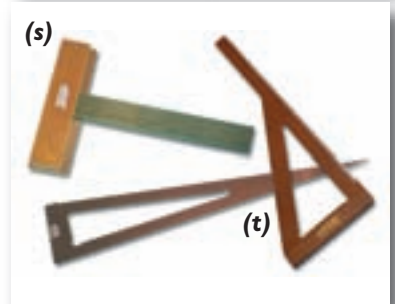

L-Squares (t)

Can be L shaped or braced, available in 800mm, 1250mm and 1750mm lengths.

NEW: L-square (braced) with metric divisions; Length 1050mm

Suction Straight Edges

Straight edge cutting bars with built in suction pads for accurate cuts. Strong and precise aluminium body which never loses its straightness. 70mm x 10mm.

Lengths available: 1500mm, 2000mm, 2600mm, 3300mm



Friendly service from a family firm - Next Day delivery

Tel 01455 202880 Fax 01455 209509



GLASS HANDLING TOOLS

Range of high quality suction lifters designed for lifting glass and other airtight surfaces (eg. plastic, metal etc)



Suction Lifters

Cast Aluminium Lifters 1 Cup Lifter

120mm suction pad. Lifting capacity approx 40kg.
Styles A and B.

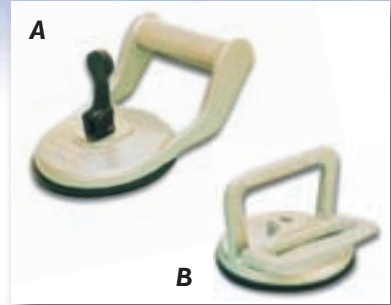

2 Cup Lifter

120mm suction pads. Lifting capacity approx 80kg.
Styles C and D.

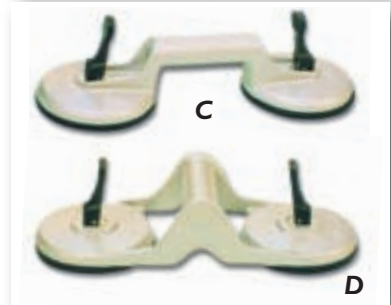

2 Cup Swivel Lifter

120mm suction pads. Both cups swivel for lifting curved glass.



3 Cup Lifter

120mm suction pads. Lifting capacity approx 140kg.



4 Cup Lifter

120mm suction pads. Lifting capacity approx 180kg.



Repair Kit *(not illustrated)*

120mm suction pad; lever; washer; axle and conical spring.

Suppliers nationwide to the Glazing Trade

Tel 01455 202880 Fax 01455 209509



GLASS HANDLING TOOLS



Suction Lifters cont'd

Plastic Lifters

1 Cup Lifter

120mm suction pad. Plastic body and lever.
One handed operation.



2 Cup Lifter

Two 120mm suction pads. Plastic body and lever.



3 Cup Lifter

Three 120mm suction pads. Plastic body and lever.



25

Special Lifters

Mounting Suction Tool

Turns through 90° in both directions for fixing show cases, aquariums, shop windows etc. 120mm suction pads.



Angular Mounting Tool

Adjustable between 40° and 300°. Holds glass from inside or outside. 120mm suction pads.



Power Pump Lifter

High safety, pump activated suction lifter. Red line on pump indicates safe suction region. Three sealing lips for security and long life. 200mm suction pad. Lifting capacity approx 100kg.

For all your Films, Tapes, Tools and Accessories

Tel 01455 202880 Fax 01455 209509



GLASS HANDLING TOOLS



Side Lifters

1 Handle "Boy"

For transporting sheet material, the load is held securely between two non-slip rubber lined clamps. Maximum operating width – 25mm. Lifting capacity approx 90kg.

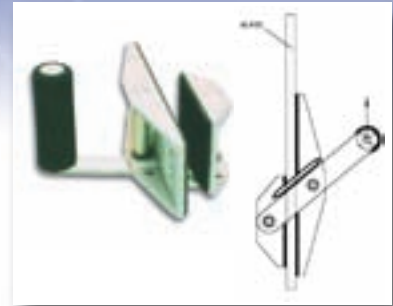

2 Handle "Coolie"

Same as the "boy" with two handles. Maximum operating width – 25mm. Lifting capacity approx 170kg.



Carrying Accessories

Carrying Strap

1700mm x 40mm with hand loops and leather chafe-resistant edging. Lifting capacity approx 100kg.



Metal Handled Carrying Strap

1350mm x 40mm with metal handles and leather chafe-resistant edging. Lifting capacity approx 150kg.



Hemp Carrying Strap *(not illustrated)*

In 40mm wide rolls. Sold by the metre.

Protection Lap

Highly resistant to slipping and cutting. 125mm x 170mm.



26

Premium quality tools at very competitive prices

Tel 01455 202880 Fax 01455 209509



GLASS HANDLING & MISCELLANEOUS TOOLS



Personal Protective Equipment (PPE)

Glaziers Gloves

Knitted with latex palm. Cut resistant.

Kevlar Lined Gloves

Rubber coated Kevlar gloves (level 4 cut protection).

Kevlar Wrist Sleeves

250mm long. High cut resistance (level 3 cut protection).

PVC Velcro Gauntlets

Economic and very popular. Lined for comfort (level 5 cut protection).

Safety Spectacles

Impact resistant to BS 2692
(can be worn over prescription glasses).



27

Glazing Tools

Putty Knife

Flat end or spear point. Brown polished wood handle.

Hacking Knife

With leather covered handle.

Glaziers Knife

Stainless steel blade 250mm x 60mm, plastic handle.

Can't see what you need? Please give us a call

Tel 01455 202880 Fax 01455 209509



MISCELLANEOUS TOOLS



Glaziers Hammer

With spring and ground head. Wooden handle.

Glazing Shovel

Solid, shock-proof plastic.

Spatula

50mm stiff metal blade.

Abrasive Diamond Hand Pads

100mm x 57mm x 30mm grinding area. Smooths and grinds glass edges. Can be used wet or dry.

120 grit (black)

220 grit (red)

360 grit (yellow)

Diamond Faced Hand Files

12mm x 44mm Used for de-burring glass.

120 grit

220 grit

400 grit

Glass Smoother

Grinds and smooths sharp edges of glass to prevent injuries.

Grinds 3–15mm thick glass.

Gasket Roller

Handy tool with nylon roller and pointed end.



28

Friendly service from a family firm – Next Day delivery

Tel 01455 202880 Fax 01455 209509



MISCELLANEOUS TOOLS



Rubber Mallet

Leaves no marks on work surfaces.
Plastic or wooden handles.

Nylon Head Hammer

With 2 white nylon heads. Plastic handle.
Replacement heads available.



Silicone Jointing Tool

For smoothing sealed surfaces. 85mm x 80mm x 7mm.



Diamond Marking Pen

With diamond point for marking glass.



Double Pocket Leather Tool Pouch

Heavy-duty suede leather with a strong 50mm wide leather belt.
2 hammer loops, 6 small pockets, 2 main nail and tool pockets.
Double stitched and riveted for reinforcement.



Suppliers nationwide to the Glazing Trade

Tel 01455 202880 Fax 01455 209509



GLASS STORAGE

BE MORE EFFICIENT AND GIVE YOUR WORKSHOP AN UP-LIFT!



A-Frame Trolley — standard

900mm wide x 1600mm long x 1200mm high. Set on 6" nylon castors - 2 swivel and 2 fixed. 300mm base board fitted at 90° to back. Retractable handle.



A-Frame Trolley — large

1000mm wide x 2000mm long x 1600mm high. Set on 4 nylon swivel castors. 300mm base board fitted at 90° to back.



A and L-Frame Storage Racks

General purpose storage in the glass workshop. Ideal for standing glass, sealed units and frames. 600mm base board at 90° to back.

Sizes available:

A-Frames 1730mm wide x 1500mm long x 2000mm high
1730mm wide x 2440mm long x 2000mm high

L-Frames 913mm wide x 1500mm long x 2000mm high
913mm wide x 2440mm long x 2000mm high



Please contact us for information on bespoke glass storage systems. We shall be pleased to produce a design and quotation.

Glass Cutting Table

Standard size 2500mm x 1500mm. Made in sturdy box section, with 18mm MDF top and fitted with bench felt.



Standard Tipping Skip

Ideal for glass off-cuts, cut profiles and general waste. Set on 4 castors with 4 way entry for fork truck lifting.



30

Carriage on Glass Storage equipment is charged at cost – phone for a quotation

Tel 01455 202880 Fax 01455 209509



GLASS FIXINGS



Glass Door Hinges

Suitable for 8mm or 10mm thick glass.

These premium quality hinges are fabricated from solid brass and are available in polished or satin chrome finish. They are self centering from 15° of the closed position and take a maximum load of 22kg per hinge.



Code: BA30051

Code	Description
BA30051 PC	Wall mounted hinge. Polished chrome plated
BA30051 SC	Wall mounted hinge. Satin chrome plated
BA30054 PC	Glass to glass hinge. Polished chrome plated
BA30054 SC	Glass to glass hinge. Satin chrome plated



Code: BA30054

3 | Pig Nose Bolts

These very popular 'fixing nuts' can be used for a variety of glass and panel holding applications. They are stainless steel construction with an M8 female thread in the back and supplied with a choice of either rubber or nylon gaskets as required. Fixings and 'back spacer' can be supplied to suit customer requirements as an optional extra.

Code	Description
BA382-10 SS	25.4mm (1") Diameter pig nose bolt. Polished stainless steel.
BA382-10 SSD	25.4mm (1") Diameter pig nose bolt. Satin stainless steel.
BA382-15 SS	38.1mm (1.5") Diameter pig nose bolt. Polished stainless steel.
BA382-15 SSD	38.1mm (1.5") Diameter pig nose bolt. Satin stainless steel.
BA382-20 SS	50.8mm (2") Diameter pig nose bolt. Polished stainless steel.
BA382-20 SSD	50.8mm (2") Diameter pig nose bolt. Satin stainless steel.



Code: BA382



Underside showing M8 fixing and washer

For all your Films, Tapes, Tools and Accessories

Tel 01455 202880 Fax 01455 209509



GLASS FIXINGS



Polished chrome plated hinges used on a glass door to a luxurious shower room



The glass table top in this hairdresser's salon has been fixed to stainless steel legs using pig nose bolts



Pig nose bolts used to secure a glass panel to a reception counter

Glass Channels

These high quality channels are made from stainless steel and brass/chrome finished. Stock sizes as below.

32

Code	Description	Outside Height	Outside Width	Inside Width	Length	Back Face
BA812C-SS	304 Grade Mirror Polished stainless steel	20mm	14.7mm	11.7mm	3.65m	Flat
BA812C-SSD	304 Grade Satin stainless steel	20mm	14.7mm	11.7mm	3.65m	Flat
BA3002-20 PB	Polished brass	12.9mm	12.9mm	7.9mm	1.8m	38-50mm Radius
BA3002-20 PC	Polished chrome	12.9mm	12.9mm	7.9mm	1.8m	38-50mm Radius
BA3002-20 SC	Satin chrome	12.9mm	12.9mm	7.9mm	1.8m	38-50mm Radius

Special sizes can be manufactured to suit customers requirements.



Code: BA812C



Code: BA302-20

Can't see what you need? Please give us a call

Tel 01455 202880 Fax 01455 209509



GLASS FIXINGS

Glass Clamps

Available in the full range of finishes, we have premium grade glass clamps to suit every glass screen or balustrade requirement. All glass clamps are supplied with gaskets and fixings and are simple to fit to any tubular or flat surface.

Suitable for 6mm Glass

Specification **"DIY" use – Small screens etc.**
Maximum recommended glass size is 700mm x 300mm. All clamps in this range have a 35–50mm radius back, although they can be used on flat surfaces.

Code	Description
BA393-20 PB	Decorative Glass Clamp with stud. 12mm hole required in glass for stud. Polished brass.
BA393-20 PC	Decorative Glass Clamp with stud. 12mm hole required in glass for stud. Polished chrome plated.
BA393-20 SC	Decorative Glass Clamp with stud. 12mm hole required in glass for stud. Satin chrome plated.
BA391-20 PB	Glass Clamp, no hole required in glass. Polished brass.
BA391-20 PC	Glass Clamp, no hole required in glass. Polished chrome plated.
BA391-20 SC	Glass Clamp, no hole required in glass. Satin chrome plated.



Code: BA393-20 PB



Code: BA393-20 PC



Code: BA391-20 PB and PC

Saving £££'s on your glazing supplies

Tel 01455 202880 Fax 01455 209509



GLASS FIXINGS

Glass Clamps cont'd

Suitable for 8mm to 10mm Glass

Specification Professional grade glass clamps with removable security pins. If security pins are used, a 13mm hole must be drilled in the glass.

Code **Description**

Flat Backed Range

BA793-F Z	Glass Clamp, Flat backed. Zinc (Galvanized effect, for powder coating or painting by customer).
BA793-F PB	Glass Clamp, Flat backed. Polished brass plated.
BA793-F SS	Glass Clamp, Flat backed. Polished stainless steel.
BA793-F SSD	Glass Clamp, Flat backed. Satin stainless steel.

Radius Backed Range

to suit 42.4mm to 60.3mm diameter tube.

BA793-20 Z	Glass Clamp, Radius backed. Zinc (Galvanized effect, for powder coating or painting by customer).
BA793-20 PB	Glass Clamp, Radius backed. Polished brass plated.
BA793-20 SS	Glass Clamp, Radius backed. Polished stainless steel.
BA793-20 SSD	Glass Clamp, Radius backed. Satin stainless steel.

Dimensions are the same for all BA793 (8-10mm) clamps.



Code: BA793-F SS



Code: BA793-F SSD

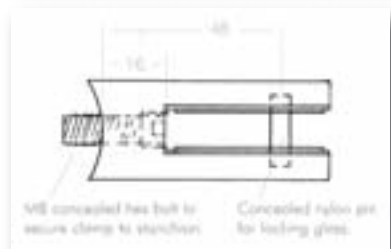

M8 concealed hex bolt to secure clamp to structure
Concealed nylon pin for locking glass



Code: BA793-20 Z



Code: BA793-20 SS

For all your Films, Tapes, Tools and Accessories

Tel 01455 202880 Fax 01455 209509



GLASS FIXINGS



Glass Clamps cont'd

Suitable for 12mm Glass

Specification	As for 8–10mm clamps
Code	Description
Flat Backed Range	
BA793/12-F SS	Glass Clamp, Flat backed. Polished stainless steel.
BA793/12-F SSD	Glass Clamp, Flat backed. Satin stainless steel.
Radius Backed Range to suit 42.4mm to 60.3mm diameter tube.	
BA793/12-20 SS	Glass Clamp, Radius backed. Polished stainless steel.
BA793/12-20 SSD	Glass Clamp, Radius backed. Satin stainless steel.



Code: BA793/12-F



Code: BA793/12-20

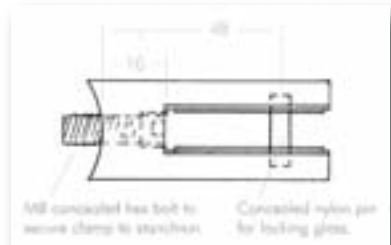

M8 concealed hex bolt to secure clamp to stainless steel. Concealed nylon pin for locking glass.

35

Dimensions are the same for all BA793 (12mm) clamps.



Balustrade fixings using both pig nose bolts and glass clamps



Glass balustrade at a residential development in Norfolk

***This catalogue is not exhaustive of all our products.
If you have not seen what you require, please telephone...
WE WILL DO OUR UTMOST TO HELP!***

Tel 01455 202880 Fax 01455 209509



Suppliers Nationwide to the Glazing Trade

Window Films



Glazing Films & Tapes



TERMS & CONDITIONS

1. All prices are quoted exclusive of carriage and V.A.T. There is a standard parcel charge for next day delivery, excluding the Highlands and non mainland locations which are subject to specific quotation.
2. NSC (Eastern) account customers Nett 30 Days. For non account customers, payment is required with order or against Pro-forma Invoice - all major credit and debit cards accepted. Credit account application forms available on request.
3. Goods remain the property of NSC (Eastern) until payment is made in full, although risk will pass to buyer upon receipt. The buyer authorises NSC (Eastern) to enter upon his/her premises for the repossession of any goods supplied by NSC (Eastern) for which payment has not been received in full.
4. NSC (Eastern) will make every effort to supply the correct goods and deliver on time, but we cannot be held responsible for consequential loss or damage, however caused.
5. The price payable is the price ruling at the date of despatch. Every effort is made to maintain prices and specifications as listed, but we reserve the right to make alterations where necessary without prior notice.
6. No claim for shortage or damage can be allowed unless the carriers or NSC (Eastern) are advised in writing within 3 days of receipt and no claims for non-delivery can be accepted unless NSC (Eastern) is advised within 10 days of invoice date.
7. Returned goods that have been correctly supplied from stock may attract a handling charge. Goods specially manufactured and correctly supplied cannot be returned.
8. It is the buyer's responsibility to establish the suitability of the product and materials for the purpose for which they are purchased.
9. The placing of an order with NSC (Eastern) signifies full acceptance of the above Terms and Conditions.

Miscellaneous Tools



Glazing Accessories



Glass Cutting Equipment



Glass Fixings



Glass Handling Tools



Glass Storage



Friendly Service from a Family Firm

Monitor Worthy Design Ltd
incorporating NSC (EASTERN)

Tel 01455 202880 Fax 01455 209509

NSC (EASTERN)



For all your Films, Tapes, Tools and Accessories

Tel 01455 202880 Fax 01455 209509 email sales@monprods.co.uk